

# **Smart Construction**

## **3D Machine Guidance Flex**

### **Installation Manual**

---



# Revision History

---

Date	Contents
2024/1/10	Bracket and fuse part numbers changed Controller specification information added Certification-related information added
2024/6/17	Note added for magnet kit (Before you read this manual:) Addition of markings for magnet kit and bracket kit
2024/7/25	Note added for magnet kit (Before you read this manual:)
2024/9/26	Adhesive application image example added Added supplemental external view and IMU installation orientation

# Before you read this manual: EARTHRAIN

---

## ● Before you start

- This manual explains how to install Smart Construction 3D Machine Guidance Flex, an application kit provided by EARTHRAIN Ltd.
- This manual describes how to install this kit and the matters to be followed for safe use.
- The installation procedure in this manual is not always applicable. Depending on the machine, installation may not be able to get done in the same way as in this manual. Check the machine first and consider whether the kit can be installed beforehand.
- Many of the accidents occur when work is done without following basic precautions. Before starting use of this kit, read and follow all the information described in this manual. Failure to follow warnings and cautions may result in serious injury or death.
- We cannot predict every situation in which customers will use our products. Therefore, the precautions described in this manual do not cover all safety-related matters. If you use this application in a situation not described in this manual, you are responsible for taking all necessary safety precautions. Never perform any of the actions prohibited in this manual.
- For displaying units, International System of Units (SI) is used. Explanation, numeral values, illustration, etc. are based on the information as of the time this manual was prepared. Due to constant product improvements, actual specifications may differ from those in this manual.
- If you have any questions or concerns, please contact the EARTHRAIN Support Center, addressed at the end of this manual.
- Regarding the use of this kit, the manufacturer and distributor do not guarantee the accuracy or take any responsibility for any machine failures due to installation.
- A person with experience in maintaining construction machines should do the work.
- Welding work should be carried out by skilled workers familiar with welding.
- Basically, install the bracket kit. Use of magnets on bulldozers or other objects that are subject to high vibration or shock may cause misalignment. When using the magnet kit, mark the initial mounting positions of the antenna, controller, and IMU, and inspect them daily.

## ● Product use

This kit is a retrofit kit to provide ICT functionality to existing vehicle-based machines. By installing this kit, the following functions will become available, enabling ICT construction even with conventional construction machines.

- 3D machine guidance function (\*1)
- 3D construction record data acquisition function

\*1 A function that acquires machine position information by GNSS positioning and provides the difference between the design data of the construction site and the traveling position for the tablet at the operator's seat

# Contents

---

## 1. For your safety

1.1 How to read warning signs (signal words)

1.2 Safety precautions

## 2. Kit overview

2.1 Kit overview (included items)

2.2 Kit overview drawing

2.3 What you need to prepare

2.3.1 Tablet device (types of tablet devices that can be used)

2.3.2 Tablet holder attachment

2.3.3 Wi-Fi router

## 3. Install kit

3.1 External view

3.2 Precautions

3.2.1 Precautions for installation

3.2.2 Precautions for attaching brackets with adhesive tape/adhesive

3.3 Preparation

3.3.1 Precautions for preparation before work

3.3.2 Tools used

3.3.3 Preparation work

3.4 Installation of brackets and magnets

# Contents

---

## **3.5 Installation of IMU**

## **3.6 Installation of GNSS antenna**

## **3.7 Installation of GNSS controller**

## **3.8 Installation of harnesses**

### **3.8.1 Machine body harness**

### **3.8.2 Additional harnesses in cab**

### **3.8.3 Antenna harness**

## **3.9 Attachment of exterior decals**

## **3.10 Installation of tablet holder attachment**

## **3.11 Mounting confirmation**



# **4. Product specifications**

# **5. Contact information**

# 1. For your safety

## 1.1 How to read warning signs (signal word)



The following warning signs are used in this manual and on this kit to identify safety messages. Follow these warning signs.

 <b>WARNING</b>	Indicates a hazard that could result in serious injury or death if not avoided.
 <b>CAUTION</b>	Indicates a risk of injury if not avoided.

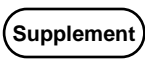
In addition, the following symbols describe items that must be observed for this kit and its installation.

<b>Note</b>	Indicates a hazard that could result in serious injury or death if not avoided.
 <b>Supplement</b>	Indicates a risk of injury if not avoided.

## 1.2 Safety precautions

 <b>WARNING</b>
<p><b>Serious injury or death could result.</b></p> <ul style="list-style-type: none"><li>• When working at heights, use an aerial work platform, scaffold steps, safety belt, etc. for safety.</li><li>• Use handrails, ladders, or steps when climbing on or off the kit-equipped machine. Always face the front of your body toward the kit-equipped machine, and support your body by placing at least three hands and feet on the handrail, ladder, or step. If no scaffolding is provided, use a stepladder or a step stool.</li><li>• Do not work in rain or bad weather.</li><li>• Be sure to observe the warning signs in this manual and on the kit for the safety of the worker and the surroundings.</li><li>• Do not modify this kit.</li></ul>
 <b>CAUTION</b>
<p><b>You can get injured.</b></p> <ul style="list-style-type: none"><li>• Always wear safety shoes and a helmet during the work.</li><li>• Do not wear loose clothes or clothes with missing buttons.</li></ul>
<b>Note</b>
When using tools, always use standard tools. Also, be sure to use the appropriate torque when tightening. Inappropriate torque can cause damage to the parts.

# 2. Kit overview

## 2.1 Kit overview (included items)

The following items are included in this kit.

- Machine body IMU
- GNSS antenna
- Controller
- Harness
- Other mounting brackets, magnets, etc.
- Decals

## 2.2 Kit overview drawing

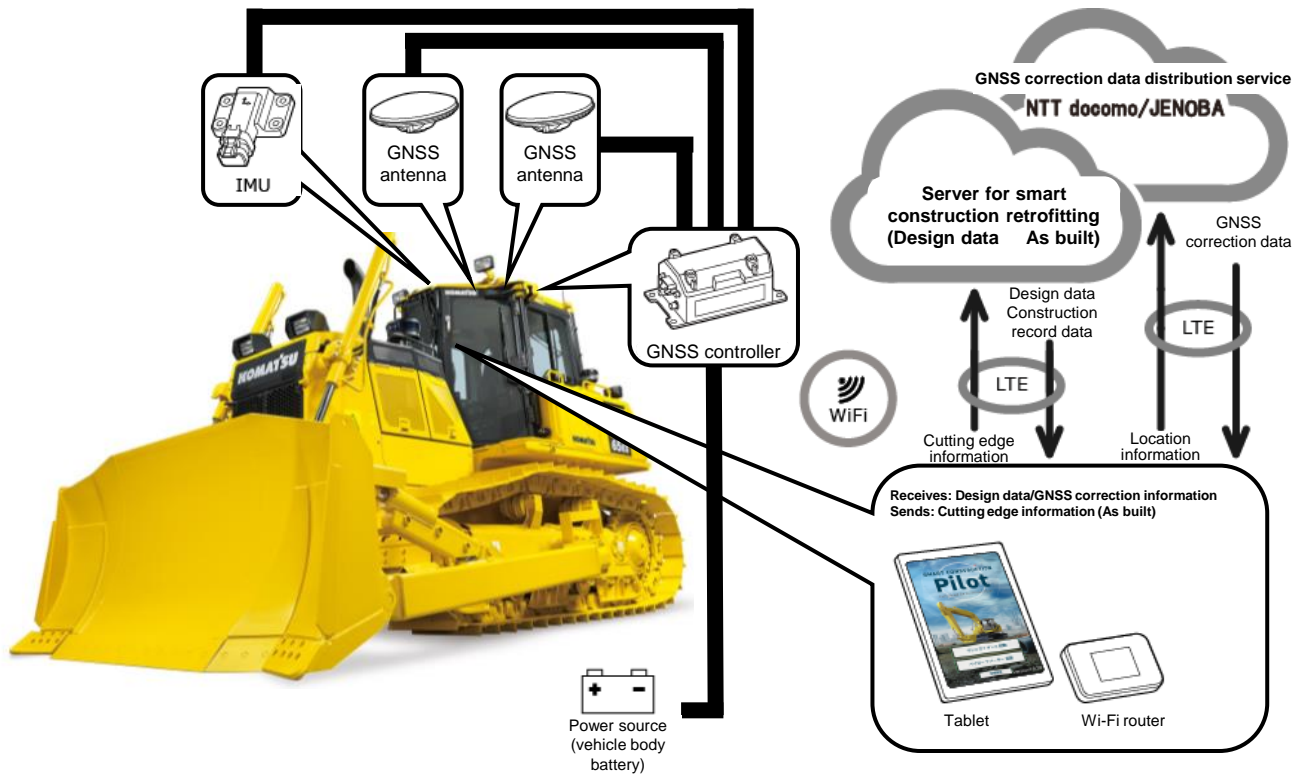

## **2.3 What you need to prepare**

After this kit is installed, a tablet device, tablet power feeding apparatus, tablet holder attachment, and Wi-Fi router are required to use the ICT functions. The kit does not include these devices and the customer must prepare them.

### **2.3.1 Tablet device (types of tablet devices that can be used)**

After this kit is installed, the ICT functions can be used by operating the tablet device on which the application software is installed.

The following tablet device has been verified to work:

- Lenovo Tab M11 Pro 2nd Gen (OS: Android12)
- \* iOS devices such as iPad cannot be used.

#### **Supplement**

- When the OS software is updated, it will be changed to the latest version at the time of update. Once updated, it is not possible to revert to the previous version that has been used. Please note that depending on when your tablet device was manufactured, updating to the latest version may slow its operation, or the tablet device may not be compatible with the latest version.
- In rare cases, internal data of the tablet device may be corrupted or deleted during software updates, or the device may not boot up. When updating the software, copy the data to a PC, etc., for backup in case of unexpected situations, and then perform the operation properly according to the operation instructions of the tablet device manufacturer. For details, please contact the tablet device manufacturer.

### **2.3.2 Tablet holder attachment**

This refers to a fixture for installing your tablet device in the cab. Prepare a holder that can securely fix the tablet.

### **2.3.3 Wi-Fi router**

To use the ICT functions, the tablet device must be connected to the GNSS controller via wireless LAN and then to the Smart Construction Server using a mobile phone line. For this purpose, prepare a Wi-Fi router that can also connect to 4G/LTE lines (generally called a mobile Wi-Fi router). In addition, the Wi-Fi router must meet the following conditions:

- Wireless LAN standard: IEEE802.11a/b/g/n/ac
- Number of Wi-Fi compatible devices that can be connected simultaneously: 2 or more
- Wi-Fi routers verified to work are “809SH” and “FS040W”.



# 3. Install kit

Install the kit to the machine body. Work safely by following the precautions and work procedures in this manual. The general work flow is as follows.

## 3.1 External view

- Example of external view



IMU connector faces left side of vehicle body

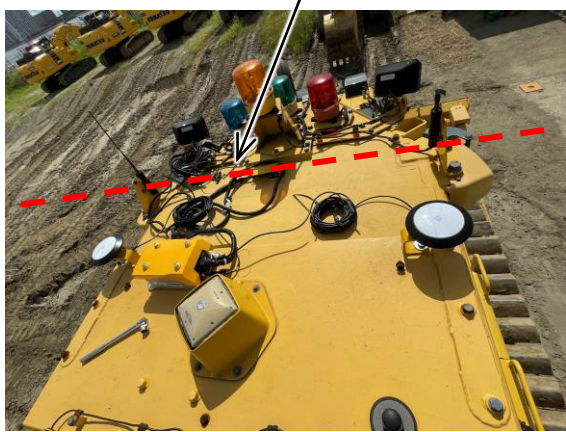

## 3.2 Precautions

### 3.2.1 Precautions for installation

#### CAUTION

**You can get injured.**

See the Shop Manual for installation procedures and notes not described in this manual.

#### Note

Use tightening torques for bolts and nuts shown in the table below unless otherwise specified.

Nominal size	Tightening torque	
	N·m	Kgf·m
M6	11.8 to 14.7	1.2 to 1.5
M8	27 to 34	2.8 to 3.5
M10	59 to 74	6 to 7.5
M12	98 to 123	10 to 12.5

### 3.2.2 Precautions for attaching brackets with adhesive tape/adhesive

When using the following brackets, attach them to the designated positions on the machine body with the adhesive tape that comes with the kit.

Apply adhesive (3M Scotch-Weld DP-8810NS or equivalent) to prevent peeling of the adhesive tape.

Bracket	Reference
Machine body IMU, controller fixing bracket	"3.4 Installation to exterior"

- Check the following precautions before attaching.
- The preparatory work described in the precautions should be performed immediately before attaching the bracket to the machine body.
- See each reference for details such as where to attach and how to remove paint.

#### ■ General precautions

#### Note

- Do not work outdoors in the rain.
- Before attaching, clean both the bracket and the attaching surface of the machine body with a cleaning solution to thoroughly remove oil, moisture, dust, rust, and dirt from the surface.
- If the machine is wet after a car wash, etc., thoroughly dry the surface before attaching. If moisture remains on the attaching surface, the adhesive strength can be reduced.
- If there has been a while between cleaning and attaching, clean it again before attaching.

#### ■ Precautions for using adhesive tape

#### Note

- If the temperature is 10°C or less, the initial adhesive strength can be increased by heating both adhesive tape and machine body to 20°C or more at the time of attachment.
- Store the adhesive tape indoors avoiding direct sunlight.
- Check that the mating surfaces are free of large distortions or gaps before attaching.
- The adhesive strength of the adhesive tape largely depends on the pressure applied at the time of attaching. Apply a strong pressure using a roller and hand pressure to attach (recommended pressure: 5 kg/cm<sup>2</sup>).
- If the adhesive tape is dented, wait until the thickness is restored before attaching.
- If air bubbles are trapped when attaching the adhesive tape, use a knife, etc., place a small cut in the tape to let the air escape instead of squeezing out using the roller.

## ■ Precautions for using adhesives

### Note

- Use the dedicated applicator and nozzle to apply the adhesive.
- After attaching the adhesive container to the applicator, check the following before attaching the nozzle (improper ratio of the main component to the hardener can cause poor curing).
  - Both the main component and hardener must be extruded.
  - The tips of the bead of both components must be aligned.
- Apply adhesive so that the bead reaches the ends of the bracket and becomes higher than the thickness of the adhesive tape. The adhesive should protrude from the bracket when it is attached (see figure below). If the amount applied is too small, the strength can be insufficient.
- The pot life of the adhesive is 8 to 12 minutes after application. The adhesive starts to cure in the nozzle after this time, so complete the application within 8 minutes.
- After attaching the bracket to the machine body, hold it for about 15 minutes for initial curing (it can be fixed with the initial adhesive strength of the adhesive tape). Do not apply external force to the bracket during this time.
- It takes 24 hours for the adhesive to cure completely.

#### <Example of adhesive application>

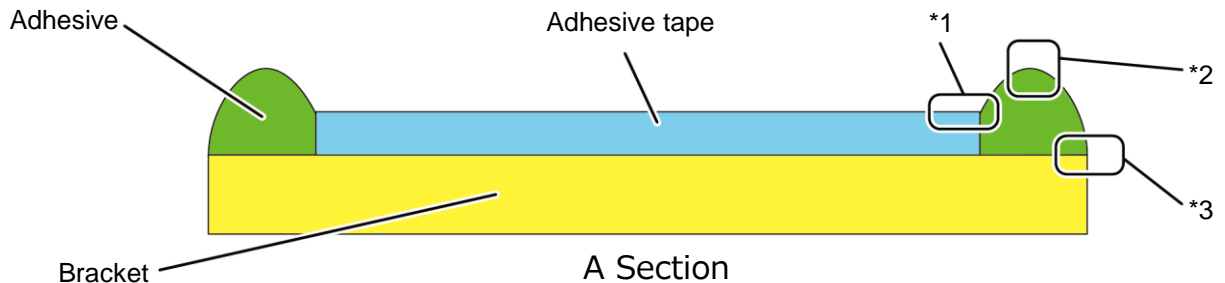

#### <Example of adhesive application image>

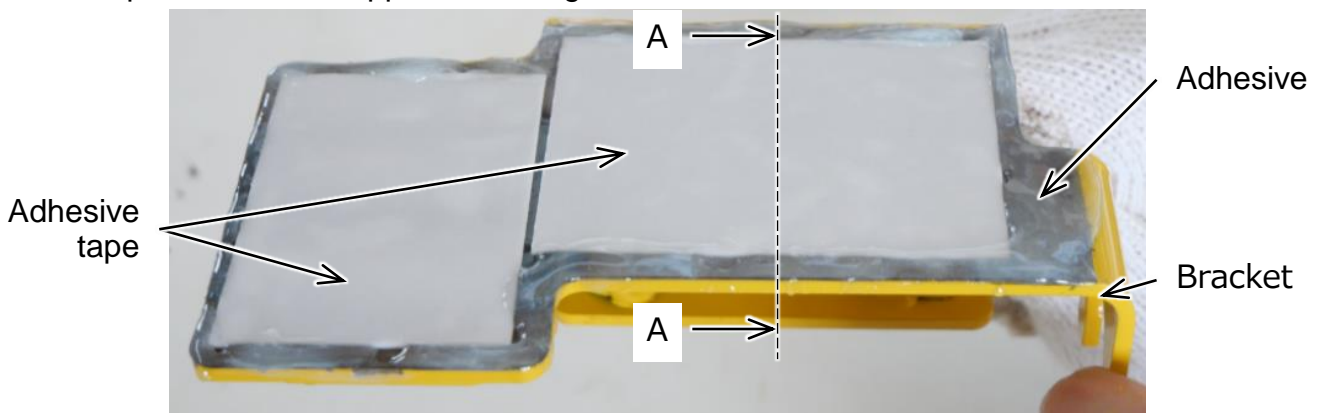

\*1 There will be no problem with the adhesion force even if the adhesive gets on the adhesive tape.

\*2 Apply it so that the bead becomes higher than the thickness of the adhesive tape. The adhesive should protrude from the bracket when it is attached.

\*3 Apply it so that the bead reaches the bracket ends.

## 3.3 Preparation

### 3.3.1 Precautions for preparation before work

#### WARNING

##### **Serious injury or death could result.**

- Pay close attention to safety measures. Work on a flat surface with an appropriate size that does not interfere with your work.
- Be sure to place the kit-equipped machine on the ground when working.
- If any mounting part is missing or damaged, do not work and contact the Support Center.

#### CAUTION

##### **You can get injured.**

Secure a work area that is not affected by wind, rain, dust, etc.

#### Note

- When unpacking, handle with care to avoid damage to the piping, wiring, and small items.
- Check the number of parts and damage to them. If any part is missing or damaged, contact the Support Center.

Confirm the SSID on the GNSS controller label when checking parts.

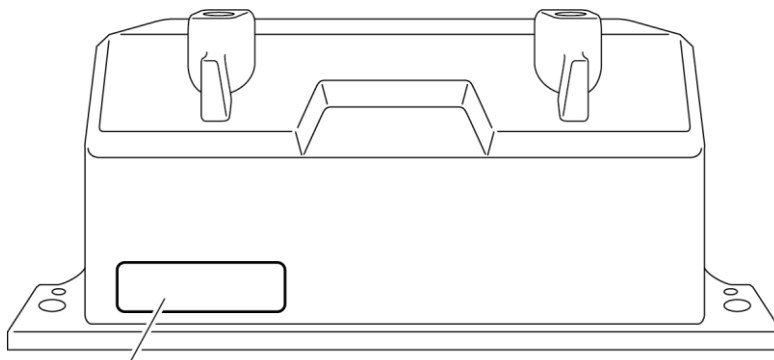

SSID indication position

### 3.3.2 Tools used

No.	Item	Specifications	Qty.
1	Socket	13 mm/17 mm/19 mm	1
2	Torque wrench	-	1
3	Nippers	-	1
4	Sander/hand grinder	-	1
5	Hexagonal wrench	-	1
6	Hand roller	-	1
7	Liquid adhesive	“ThreeBond TB1374/LOCTITE K965” or equivalent	1
8	Paint for repainting	Prepare the same color as the construction machine.	1
9	Adhesive	3M Scotch-Weld DP-8810NS or equivalent	1
10	Applicator	3M Scotch-Weld EPX PLUS II applicator	1
11	Mixing nozzle	3M Scotch-Weld EPX 10:1 mixing nozzle (45 mL)	6

#### Supplement

We recommend using a sander or hand grinder to remove the paint. Also, you can remove the paint cleanly using a special tool like a flap wheel or Skill Touch (flexible grinding wheel).

### 3.3.3 Preparation work

#### Note

When using tools, always use standard tools. Also, be sure to use the appropriate torque when tightening. Inappropriate torque can cause damage to the parts.

- Use an aerial work platform, etc., to secure a stable footing.
- Park the machine to be equipped with this kit on a level place.
- Put the lock lever in the LOCK position and then stop the engine.
- See the Shop Manual (Example: Testing and Adjusting “Release Remained Pressure from Hydraulic System”) to remove the pressure remaining in the hydraulic circuit.
- Wait until the system operating lamp goes out (up to 6 minutes after the start switch is turned OFF). Confirm that the lamp is off and then turn the disconnect switch to the OFF position.
- Before disconnecting electrical wiring and hoses, note the connector numbers and installation locations.
- When connecting lock-hook type connectors on the harnesses, insert the connector until a click is heard when the hook engages.

### 3.4 Installation of brackets and magnets

#### Note

When using tools, always use standard tools. Also, be sure to use the appropriate torque when tightening. Inappropriate torque can cause damage to the parts.



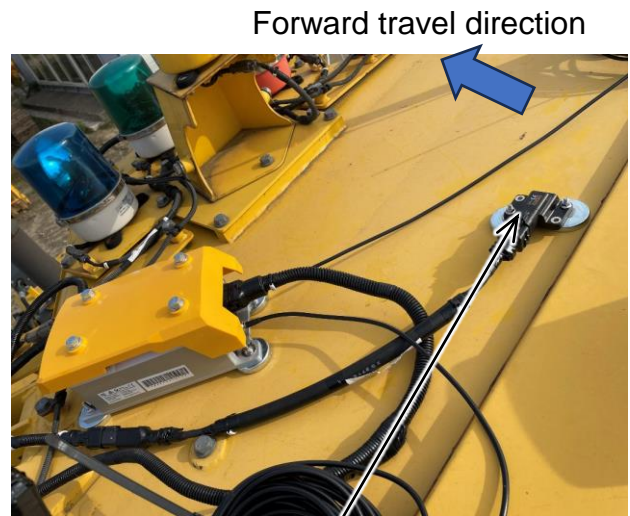
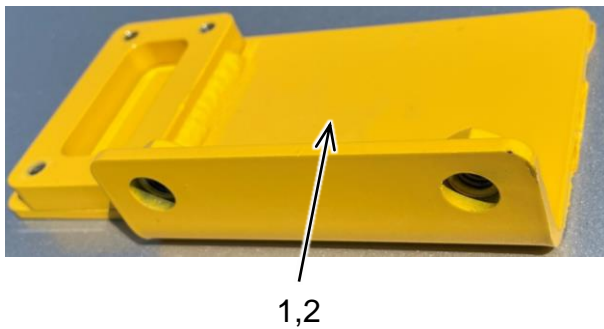

#### ◎ Installation of IMU fixing bracket and magnets



##### ■ Example of installation



3,4,5,6

##### ■ Mounting parts

No.	Parts	Form	Parts number	B	M	Qty.
1	IMU fixing bracket *1		2AB-06-22311	●		1
2	Adhesive tape for IMU fixing bracket *1		2AB-06-12970	●		1
3	Magnet *2		LL-L02-0000170		●	2
4	Bolt *2		LL-L02-0000180		●	2

No.	Parts	Form	Parts number	Qty.
5	Washer *2		LL-L02-00-00190	2
6	Nut *2		LL-L02-00-00200	2

### ■ Installation procedure

#### **WARNING**

**Serious injury or death could result.**

When working at heights, use an aerial work platform, scaffold steps, safety belt, etc. for safety.

#### Supplement

#### How to use adhesive tape and adhesive:

- Before attaching, see “3.2.2 Precautions for attaching brackets with adhesive tape/adhesive” to check the precautions and perform the preparation work.
- Attach adhesive tape to the positions shown in the figure below, and apply adhesive to the hatched areas (unpainted parts on the bracket not covered with tape).

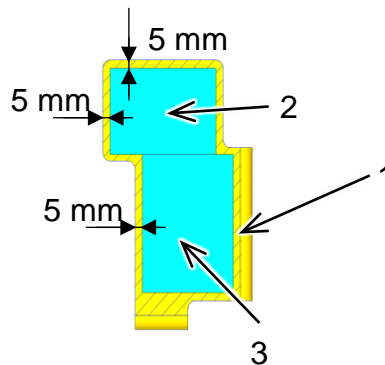

1. Remove the paint from the attaching part.
2. Install the IMU fixing bracket (1) with adhesive tape and adhesive. Refer to the “Example of installation”. Apply a strong pressure using a roller and hand pressure to attach (recommended pressure: 5 kg/cm<sup>2</sup>).
3. Cure the adhesive tape area for at least 24 hours.
4. When installing with magnets, assemble them with the IMU and install them at a position parallel to the ground.



5. Install the IMU so that the connector is on the left side of the car body as shown in the figure below. When installing the bracket, please consider the direction of the bracket.

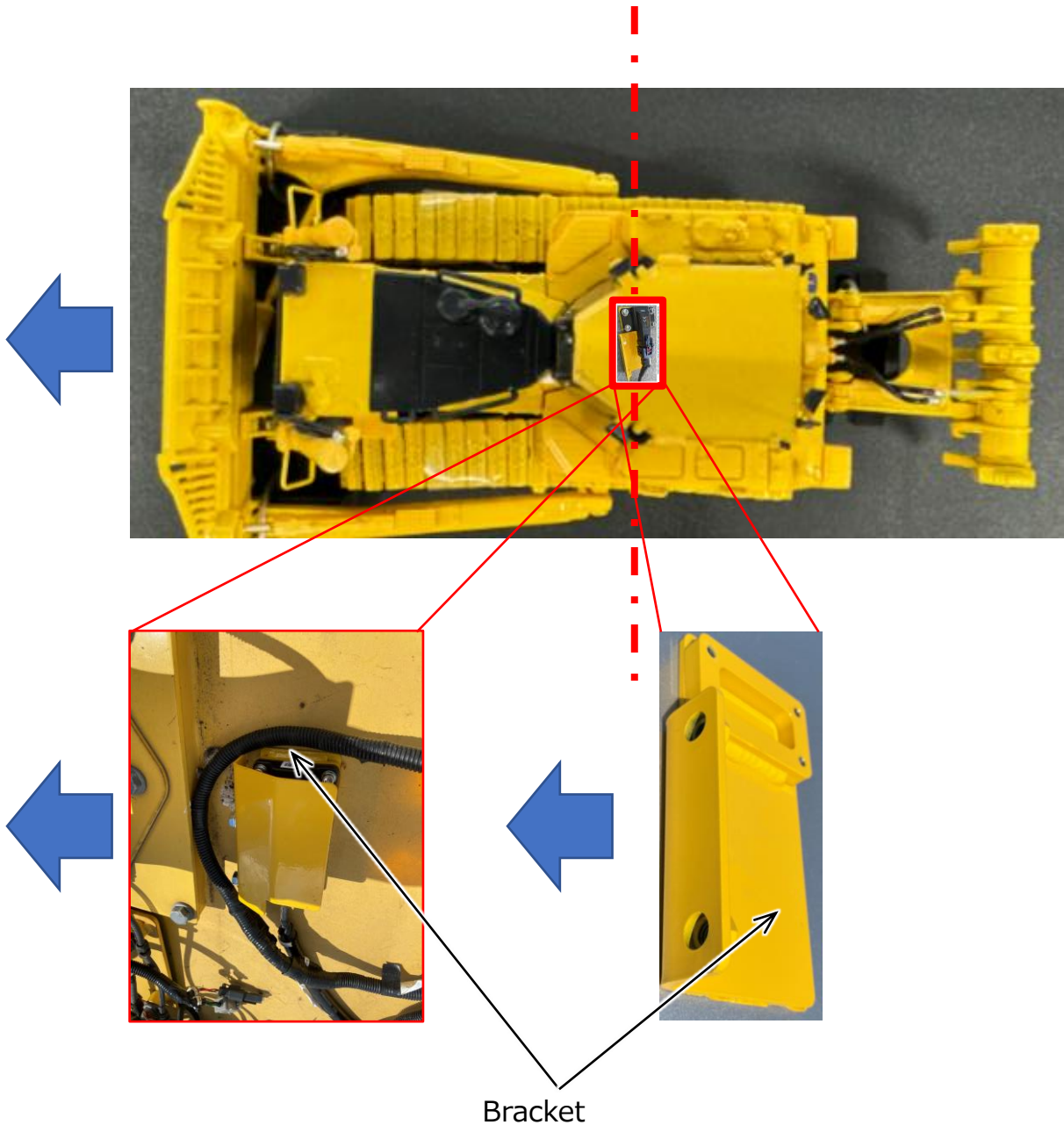

### Note

- If too much paint was removed, repaint it with the same color. If left untreated, it can cause rust.
- Install away from heat sources.
- Do not install to a place that shakes constantly due to vibrations.
- Install it parallel to the ground at a position where the exterior is not distorted.

### © Installation of controller fixing bracket and magnets

#### ■ Example of installation









1,2



3,4,5,6

#### ■ Mounting parts

No.	Parts	Form	Parts number	B	M	Qty.
1	GNSS controller fixing bracket *1		2AB-06-13230	●		1
2	Adhesive tape for GNSS controller fixing bracket *1		2AB-06-12910	●		1
3	Magnet *2		LL-L02-0000170		●	4
4	Bolt *2		LL-L02-0000180		●	4

No.	Parts	Form	Parts number	B	M	Qty.
5	Washer *2		LL-L02-0000190		●	4
6	Nut *2		LL-L02-0000200		●	4

### ■ Installation procedure

#### Note

- Install away from heat sources.
- Do not install to a place that shakes constantly due to vibrations.
- In case of brackets, the mounting surface, and in case of magnets, the ground surface should all touch and be within reach of the harness.

#### Supplement

#### How to use adhesive tape and adhesive:

- Before attaching, see “3.2.2 Precautions for attaching brackets with adhesive tape/adhesive” to check the precautions and perform the preparation work.
- Attach adhesive tape to the positions shown in the figure below, and apply adhesive to the hatched areas (unpainted parts on the bracket not covered with tape).

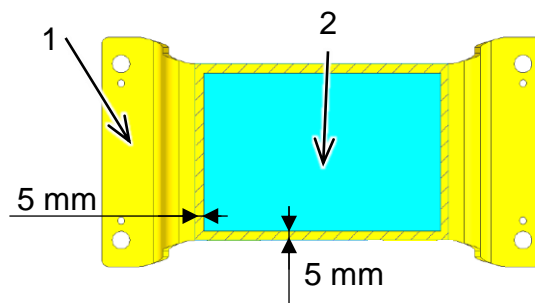

Install the GNSS controller fixing bracket (1) to the exterior.

1. Remove the paint from the attaching part.
2. Install the controller fixing bracket (1) with adhesive tape and adhesive. Refer to the “Example of installation”. Apply a strong pressure using a roller and hand pressure to attach (recommended pressure: 5 kg/cm<sup>2</sup>). When installing square sheets, work in the order of tacking, welding, and finishing.
3. Cure the adhesive tape area for at least 24 hours.
4. When installing with magnets, assemble them with the controller and install them at a position parallel to the ground.

© Installation of GNSS antenna fixing bracket

■ Example of installation



1 3



9 10

■ Mounting parts

No.	Parts	Form	Parts number	B	M	Qty.
1	Bracket *1		2AB-06-15450	●		2
2	Bracket *1		2AB-06-80140	●		2
3	Bolt (M16, length 35) *1		01010-81635	●		2
4	Washer (for M16) *1		01643-31645	●		2
5	Bolt (M12, length 35) *1		01034-81235	●		2
6	Washer (for M12, large washer ø36) *1		175-54-34170	●		2
7	Bolt (M10, length 35) *1		01010-81035	●		2

No.	Parts	Form	Parts number	B	M	Qty.
8	Washer (for M10, large washer $\varnothing 36$ ) *1		417-43-16210	●		4
9	Magnet *2		LL-L02-0000440		●	2
10	Pole (25 cm) *2		LL-L02-0000450		●	2

\*1 Included only in bracket kit.

\*2 Included only in magnet kit.

■ Installation procedure

Install the GNSS antenna fixing bracket and magnets. Refer to the “Example of installation”.

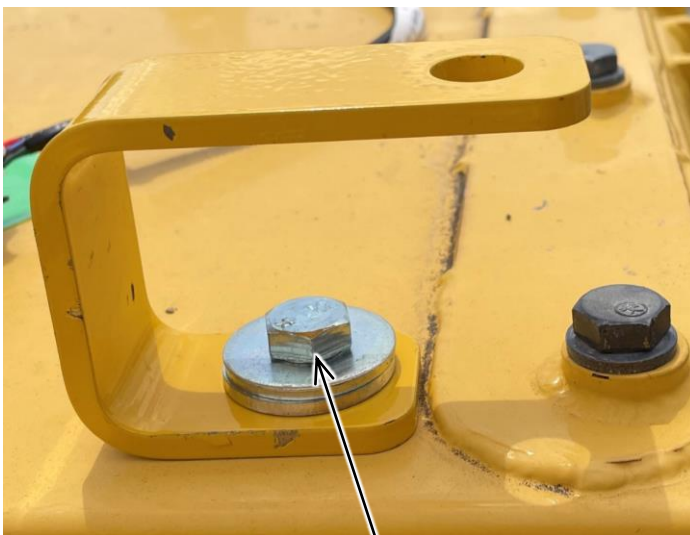

1,5,6



9,10

### 3.5 Installation of IMU

#### Note

Do not overtighten bolts during installation. Overtightening can cause damage to the IMU.

#### Supplement

When installing, apply liquid adhesive (“ThreeBond TB1374/LOCTITE K965” or equivalent) to the IMU mounting bolts.

#### ■ Example of installation

Install the machine body IMU to the IMU fixing bracket as shown in the figure below.



1,2,3

#### Note

Install the IMU as parallel as possible to the revolving frame surface (with the IMU connector facing the left side of the machine body). Large deviations from parallel can result in inaccuracy.

■ Mounting parts

No.	Parts	Form	Parts number	B	M	Qty.
1	IMU		2AB-06-80310 (赤色の●印)	●	●	1
2	IMU mounting bolt *1, *2		01252-A0516	●		4
3	IMU mounting washer *2		01601-20513	●		4

\*1 Tightening torque: 2.73 N·m

\*2 Included only in bracket kit.



### 3.6 Installation of GNSS antenna

■ Example of installation



■ Mounting parts

No.	Parts	Form	Parts number	B	M	Qty.
1	GNSS antenna *1		2AB-06-11120	●	●	2
2	Nut		02205-11015	●		2

No.	Parts	Form	Parts number	B	M	Qty.
3	Washer		01643-31645	●		4
4	Bolt		02010-81057	●		2

\*1 Tightening torque: 32 N·m

■ Installation procedure

1. Screw the antenna/washer/nut (/bolt) all the way in.
2. Slightly loosen and bring the antenna cable to the inside of the machine body.
3. Turn the nut in the loosening direction and then apply torque (32 N·m).
4. When using magnets, assemble the antenna and pole.

**Note**

It is recommended that antennas be placed as far apart and symmetrically as possible. Symmetry facilitates major calibration.

**3.7 Installation of GNSS controller**

■ Example of installation

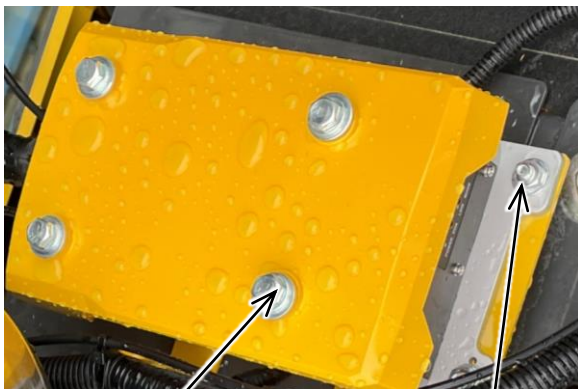

3,4

1,2,5,6



3,4



**■ Mounting parts**

No.	Parts	Form	Parts number	B	M	Qty.
1	Controller		LL-2AB-06-11112	●	●	1
2	Bolt (M8, length 25)		01024-80825	●		4
3	Cover		LL-2AB-06-11220	●	●	1
4	Bolt (M8, length 20) *1		01024-80820	●	●	4
5	Nut (M8)		01580-10806	●		4
6	Washer		01643-30823	●		4

\*1 Tightening torque: 12.5 N·m

■ Installation procedure (reference image of excavator)

1. Install the GNSS controller to the GNSS controller fixing bracket as shown in the figure below.
2. Install the cover to the top of the GNSS controller and fix it with bolts as shown in the figure below. (12.5 N·m)

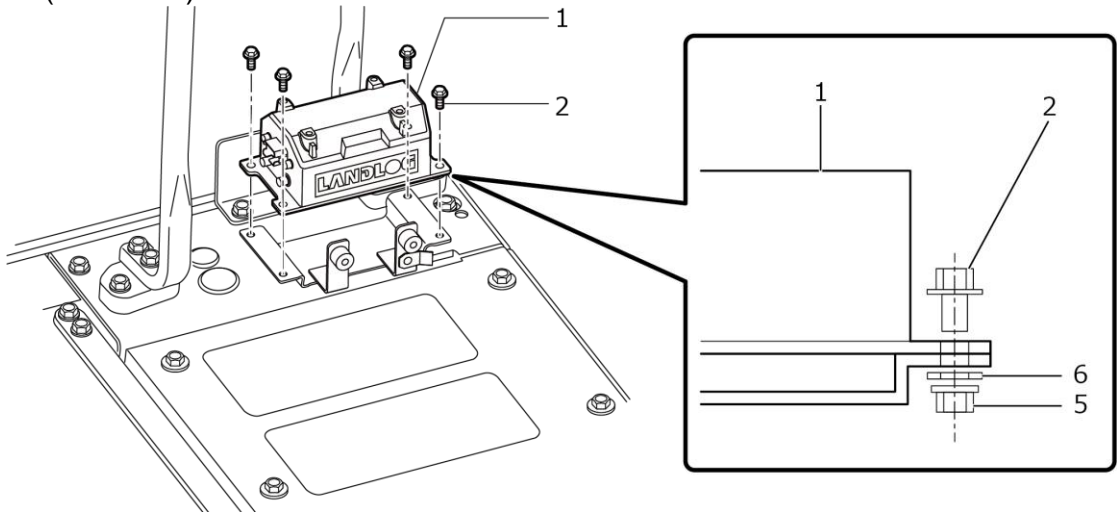

### **3.8 Installation of harnesses**

#### **3.8.1 Machine body harness**

**⚠ WARNING**

**Serious injury or death could result.**

Before installing harnesses, turn the disconnect switch to OFF (turn off the power). Installing harnesses when the disconnect switch is ON (energized) can cause an electric shock.

**Note**

When engaging the IMU connector, push the red hook toward the insertion side after inserting the connector. Be careful not to apply excessive force to each connector mating part.

■ Example of installation

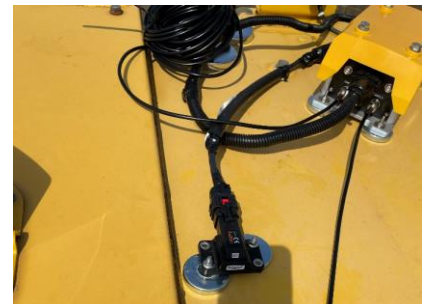

■ Mounting parts

No.	Parts	Form	Parts number	B	M	Qty.
1	Machine body harness *1		LL-L02-00-00390	●	●	1
2	IMU harness		LL-L02-00-00760	●	●	1
3	IMU cover *1		LL-2AB-06-22440	●		1
4	Bolt *1		01024-80820	●		2
5	Cable tie fixing base		LL-2AB-06-12280	●	●	20
6	Cable tie		134-03-61410	●	●	20
7	Ferrite core		LL-2AB-06-12780	●	●	1

■ Installation procedure

**Note**

- Use cable ties (6) and cable tie fixing bases (5) to secure the wiring and avoid interference.

1. Cut out the conduit in the part of the machine body harness (5) closest to the controller and install the ferrite core (7).

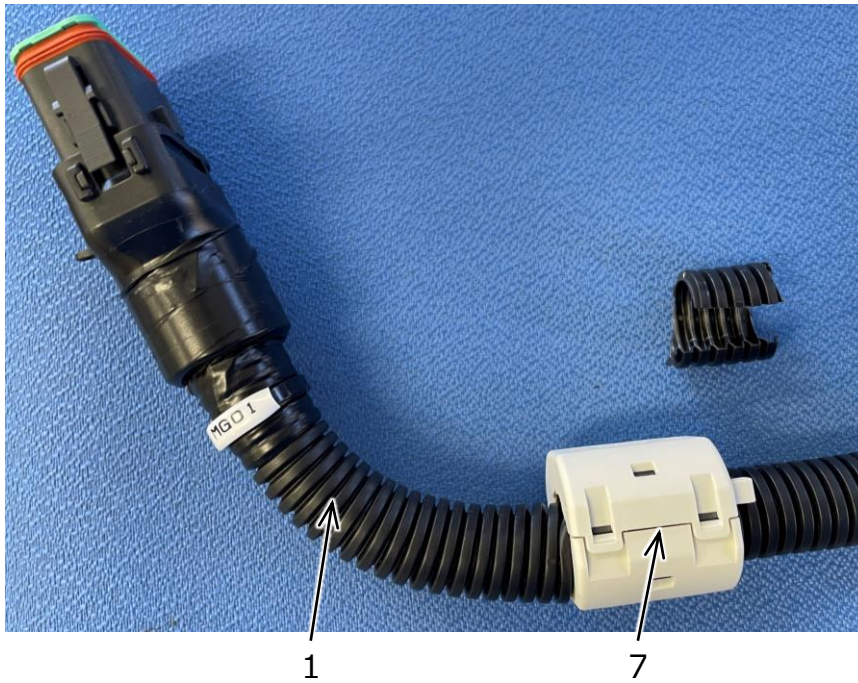

2. Assemble the installed ferrite core (7) with tape.



3. Connect the arm IMU and the harness (see next page).

Connection method:

① Insert the rubber cushion of the bucket harness into the IMU fixing bracket.

② Insert the connector of the bucket harness into the bucket IMU. Insert the red lock until a click is heard.

4. Connect the controller and the machine body harness.

5. Use cable tie fixing bases (5) and cable ties (6) as necessary to secure harnesses.

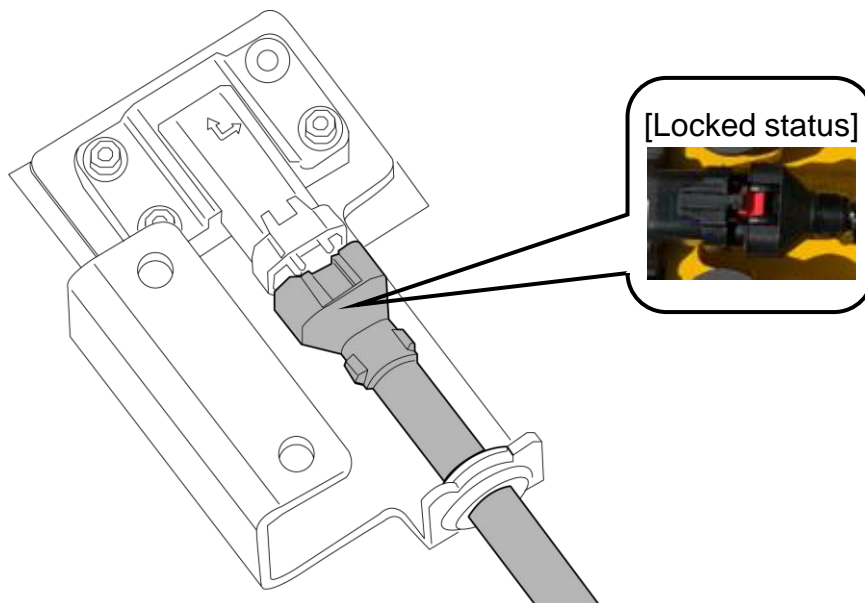

### 3.8.2 Additional harnesses in cab

#### ■ Example of installation



1



6

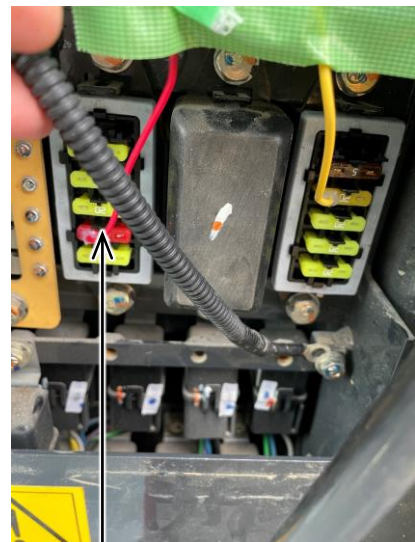

4

**■ Mounting parts**

No.	Parts	Form	Parts number	B	M	Qty.
1	Power harness		LL-L02-0000400	●	●	1
2	Floor harness		LL-L02-0000420	●	●	1
3	Fuse *1		2AB-06-12860	●	●	2
4	Fuse *1		2AB-06-80100	●	●	2
5	Grounding harness with bullet terminal *1		LL-L02-0000750	●	●	1
6	Cigar lighter socket power harness *1		LL-L02-0000280	●	●	1
7	Cable tie *2		08034-20834	●	●	50
8	Connector *3		134-06-65280	●	●	1
9	Connector *3		208-06-27730	●	●	1

\*1 Use the required item.

\*2 Use the required number of items.

\*3 Use when necessary.

## ■ Installation procedure

### Note

- Use cable ties (7) to secure the wiring and avoid interference.
- When securing harnesses, be sure to use cable ties at conduit-protected parts. Securing harnesses at tape wound parts or bare wire parts, as shown in the figure below, can cause damage and breakage of wires.
- Be sure to pass the power harness inside the main harness. If it is passed outside the main harness, as shown in the figure below, it can be caught between the frame and the main harness.
- Install harnesses so that they do not interfere with surrounding parts or get bent.
- Use a tester to check in detail the fuses on the kit-equipped machine.
- Select a grounding point with a potential difference of 24 V from the fuse to be used.

1. Secure the power harness (1) and floor harness (2) to the main harness using cable ties. Bundle and secure excess harnesses.
2. Ensure power supply by using fuses (3), (4) and harness (5), or cigar lighter socket power harness (6).
  - ① Connect to the constant power supply section of the fuse box and the key-switched power supply section (ACC power supply section), respectively.
  - ② Connect the ground terminal of the power harness to the grounding point. Connect to the appropriate point depending on the machine model.

### 3.8.3 Antenna harness

#### ■ Example of installation



1

<Controller connection part>

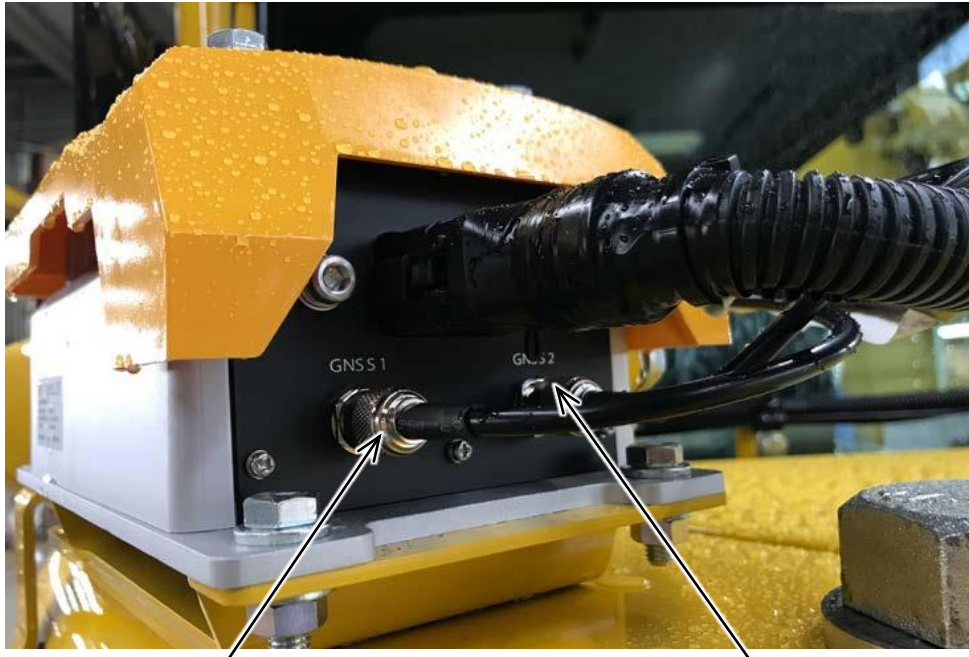

Main antenna connection part  
(GNSS1)

Sub antenna connection part  
(GNSS2)

■ Mounting parts

No.	Parts	Form	Parts number	B	M	Qty.
1	Antenna harness *1 (10 m)		LL-2AB-06-15510	●	●	2

\*1 Attach the ferrite core connector to the controller side.

■ Installation procedure

**Note**

Use cable ties to secure the antenna harness and avoid interference.

1. Secure the harnesses at appropriate locations and connect the controller and the GNSS antenna.



### **3.9 Attachment of exterior decals**

Attach decals to the kit-equipped machine.

■ Mounting parts

No.	Parts	Form	Parts number	B	M	Qty.
1	Decal for doors		LL-2AB-06-12581	●	●	2

■ Installation procedure

1. Attach decal (1) to the right side of the kit-equipped machine. Attach to where it is easy to attach depending on the actual machine.
2. Attach decal (1) to the left side of the kit-equipped machine. Attach to where it is easy to attach depending on the actual machine.

### **3.10 Installation of tablet holder attachment**

 **WARNING**

**Serious injury or death could result.**

- Put the lock lever in the LOCK position and stop the engine of the kit-equipped machine before attaching or detaching the tablet device or tablet holder attachment and adjusting its position.
- The tablet holder attachment must be securely installed in a place that meets all the following conditions so it will not fall off. Obstruction of the operator’s view while operating the kit-equipped machine can result in serious personal injury. In addition, if the tablet device or tablet holder attachment interferes and falls off, the operator can get injured, or the tablet device can get damaged.
  - The tablet holder attachment does not obstruct the operator’s view while operating the kit-equipped machine.
  - The tablet holder attachment does not interfere with the operator’s hand or else while operating the kit-equipped machine.
  - The tablet holder attachment can be installed securely so it will not fall off.

**Supplement**

Various types of tablet holder attachments are available on the market. Prepare one whose size is suitable for the tablet device to be used.

### 3.11 Mounting confirmation

1. After installing all equipment, restore removed covers, if any, and check again for fallen or missing parts.
2. Check if the system starts normally.
  - ① Turn the disconnect switch to ON.
  - ② Turn the ignition switch to ON to supply power (it is not necessary to start the engine).

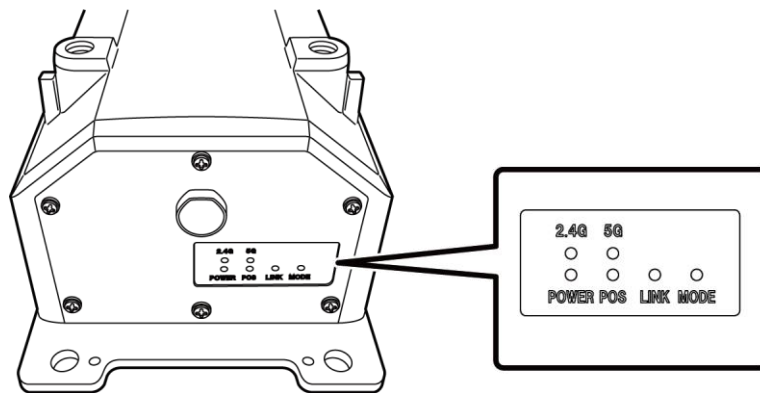

- ③ Check the LED lamp of the GNSS controller.

POWER	Power: Lights up when the ignition switch is in the ON position.
POS	Positioning confirmation: Lights up when at least GNSS point positioning is working. It stays off when no reception or no positioning is available.
LINK	Lights up when correction data is received. It stays off during operation check.
MODE	Flashes in the RTK-Float mode. Lights up steadily in the RTK-Fix mode. It stays off during operation check.
2.4G	Lights up when 2.4 GHz Wi-Fi is used.
5G	Lights up when 5 GHz Wi-Fi is used. * In Japan, it is prohibited to use 5 GHz Wi-Fi outdoors. Therefore, it does not light up when used in Japan.

3. Check the installed harnesses, etc., for interference and bends.

# 4. Product specifications



Product Name		Smart Construction Retrofit
Controller Model Name		SCRF00AT02 / SCRF00AT03
Controller Model Number		LL-1001-00-00-0101 / 2AB-06-11112
Part Name		CONTROLLER
Controller Power Supply	Rated volted	10 - 30V
	Recommended Fuse Capacity	10A
Current Consumption		0.2A(24V)
Water Resistance / Dust Resistance		JIS D0203 S2 / JIS Z8901 8 types
Operating Temperature Range		-30°C to +85°C
Manufacturer		EARTHRAIN Ltd.
Factory		Akasaka Tech
Controller Country of Origin		Japan
Wi-Fi Specification		802.11 a/b/g/n/ac
Standards (EN,FCC)		EN 300 328 V2.1.1 / EN 300 328 V2.2.2 EN 301 893 V2.1.1, EN 303 413 V1.1.1 EN 301-489-1 V2.2.3, EN 301-489-17 V3.1.1 EN 301-489-19 V2.1.1 ,EN 62368-1:2014+A11:2017 FCC Part 15 Subpart E:2018 FCC Part 15 Subpart B:2020
Max EIRPs (per band and function)		WLAN2.4GHz(EN): 14.48 dBm eirp WLAN5GHz(FCC): 11a: 17.86 dBm eirp, 11n-20: 17.40 dBm eirp 11ac-20: 17.42 dBm eirp, 11n-40: 15.47 dBm eirp 11ac-40: 15.34 dBm eirp, 11ac-80: 13.38 dBm eirp
Vibration		Frequency : 8.3Hz-400Hz, Test time : 20min, Acceleration:8.9G, Total vibration: max. 1mm
Vibration Durability		Frequency : 66.7Hz, Test time 4 hours up and down, 2 hours left and right, 2 hours before and after, Acceleration : 8.9G
Sweep Vibration Durability		Frequency : 8.3Hz - 400Hz, Cycle : 20 min. (1 Reciprocal), Test time : 6 hours up and down, 6 hours left and right, 6 hours before and after, Acceleration : 8.9G, Full amplitude : Max 1.0mm

Impact	'Impact acceleration : 50G, Impact action time : 11msec, Number of tests : up and down, left and right, before and after, 5 times in each of the 3 axes in both directions, Total 30 times
Salt Water Spray	'Test temperature : 35 °C, Salt water concentration : 5%, Spray volume : 0.5 -
Type of Modulation	BPSK, QPSK
Frequency Band	2400-2835.5MHz, 5150-5250MHz, 5250-5350MHz, 5470-5725MHz, 5725-5895MHz,
Frequency of Operation	2412-2472MHz, 5180-5240MHz, 5260-5320MHz, 5500-5700MHz, 5745-5825MHz,
Antenna Gain	2.4GHz : 2.1dBi 5GHz : 2.4dBi
Weight	2.1kg
Emission Designation (ITU Code)	G1D/G7D
Transmit Power or Power Range	Burst Mode Tx 11b (Duty=46.8%):488mW 11ac RX 5G:358mW Sleep Mode:1.8mW
Bandwidth	5MHz, 20MHz, 40MHz, 80MHz
Channel Spacing	5MHz, 20MHz, 40MHz, 80MHz
GNSS Reception Specifications	GPS GLONASS Galileo Beidou QZSS
Wireless Connection Specifications (option)	RS232C
Body Size ※Without Sunshade Cover	130mm(W) x 250mm(D) x 100mm(H)

## ■ FCC Regulatory Information

• Product name: Smart Construction Retrofit / Smart Construction 3D Machine Guidance  
This device complies with part 15 of the FCC Rules. Operation is subject to the following two conditions: (1)

This device may not cause harmful interference, and (2) this device must accept any interference received, including interference that may cause undesired operation.

- Company name : KOMATSU AMERICA CORP.
- Address: 8770 W Bryn Mawr Ave Suite 100, Chicago, IL 60631 U.S.A.
- Telephone number: +1 (847) 437-5800

## FCC CAUTION

Changes or modifications not expressly approved by the party responsible for compliance could void the user's authority to operate the equipment.

- Properly shielded and grounded cables and connectors must be used for connection to host computers and / or peripherals in order to meet FCC emission limits.
- Machine harness with ferrite core must be used for RF interference suppression.

Note: This equipment has been tested and found to comply with the limits for a Class A digital device, pursuant to part 15 of the FCC Rules. These limits are designed to provide reasonable protection against harmful interference when the equipment is operated in a commercial environment. This equipment generates, uses, and can radiate radio frequency energy and, if not installed and used in accordance with the instruction manual, may cause harmful interference to radio communications. Operation of this equipment in a residential area is likely to cause harmful interference in which case the user will be required to correct the interference at his own expense.

## Compliance with FCC requirement 15.407(c)

Data transmission is always initiated by software, which is passed down through the MAC, through the digital and analog baseband, and finally to the RF chip. Several special packets are initiated by the MAC. There are the only ways the digital baseband portion will turn on the RF transmitter, which it then turns off at the end of the packet. Therefore, the transmitter will be on only while one of the aforementioned packets is being transmitted. In other words, this device automatically discontinues transmission in case of either absence of information to transmit or operational failure.

Frequency Tolerance: 2.4GHz Band  $\pm 25$  ppm, 5GHz Band  $\pm 20$  ppm

This transmitter must not be co-located or operated in conjunction with any other antenna or transmitter.

This equipment complies with FCC radiation exposure limits set forth for an uncontrolled environment and meets the FCC radio frequency (RF) Exposure Guidelines. This equipment should be installed and operated keeping the radiator at least 20cm or more away from person's body.

■ SDoC

This telecommunication equipment conforms to the standard or technical requirements of NBTC. เครื่อง ึ่งโทรคมนาคมและอุปกรณ์นี้ ้มีคี่ วามสอดคล้องตามมาตราฐานหรือ ้ข้อ กา หนดทางเทคนิคของ กสทช.

This radiocommunication equipment is exempted to possess license, user license, or radiocommunication station license as per NBTC notification regarding radiocommunication equipment and radiocommunication station has been exempted for license according to radio communication act B.E.2498.



■ For Singapore



■ For Argentina



認可番号 : XXXXXXXXX

改定後追記予定

■ For Brazil



HHHHH-AA-FFFFF

改定後追記予定

Este equipamento não tem direito à proteção contra interferência prejudicial e não pode causar interferência em sistemas devidamente autorizados.

Para consultas, visite: [www.anatel.gov.br](http://www.anatel.gov.br)

■ For Mexico

IFT + XXXXXXXXXX - XXXX

改定後追記予定

**La operación de este equipo está sujeta a las siguientes dos condiciones: (1) es posible que este equipo o dispositivo no cause interferencia perjudicial y (2) este equipo o dispositivo debe aceptar cualquier interferencia, incluyendo la que pueda causar su operación no deseada.**

## ■ For Taiwan



CCXXxxYYyyyZzW

『取得審驗證明之低功率射頻器材，非經核准，公司、商號或使用者均不得擅自變更頻率、加大功率或變更原設計之特性及功能。』

低功率射頻器材之使用不得影響飛航安全及干擾合法通信；經發現有干擾現象時，應立即停用，並改善至無干擾時方得繼續使用。

前述合法通信，指依電信管理法規定作業之無線電通信。

低功率射頻器材須忍受合法通信或工業、科學及醫療用電波輻射性電機設備之干擾。』

『應避免影響附近雷達系統之操作。』

『高增益指向性天線只得應用於固定式點對點系統。』

Scheduled to be added after revision



# 5. Contact information

## ■ Contact information for inquiries on products and defects

EARTHRAIN Ltd.

You can contact support via the following site:

<https://support.smartconstruction.com/hc/requests/new>

Select your region from the language options at the top right of the page.

Smart Construction 3D Machine Guidance Flex

Issued by

EARTHRAIN Ltd.

Izumi Garden Tower 29th floor,  
1-6-1, Roppongi, Minato-ku, Tokyo

Unauthorized copying or reprinting is prohibited.